

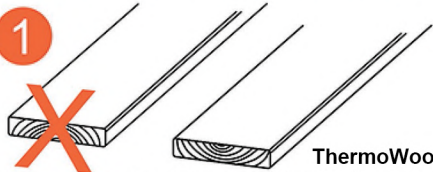

1



ThermoWood – borovica

Jadrová strana (pravá strana obsahujúca dreň) je pohľadová strana profilov zo severskej borovice.

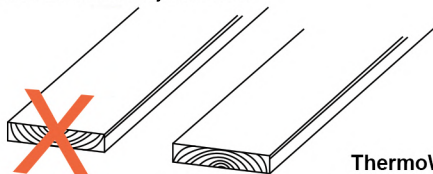

ThermoWood – smrek

Beľová strana je pohľadová strana profilov zo severského smreku.

2

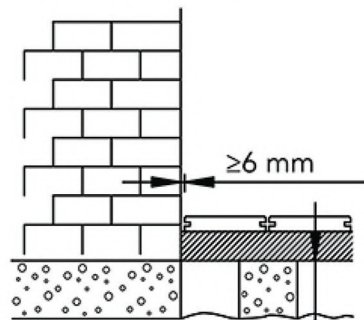

TIP: Použite rektifikačné terče BUZON



≥6 mm
≥42 mm

4

sklone dosiek 1% = 1 cm na 1 m

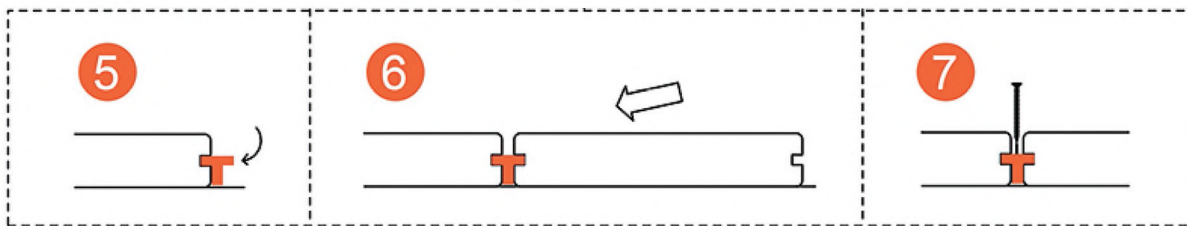
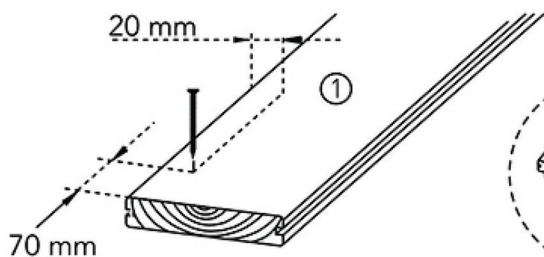
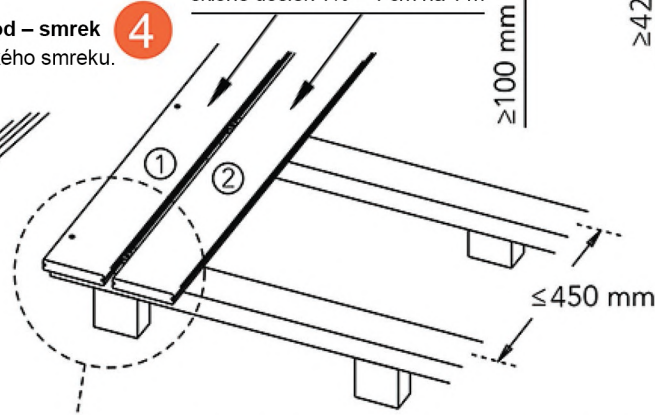

TIP: Pre zlepšenie ventilácie použite KLIP LIGO C/47

8



9

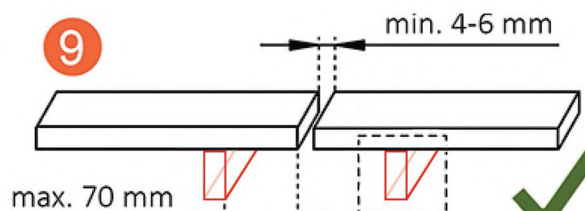

10

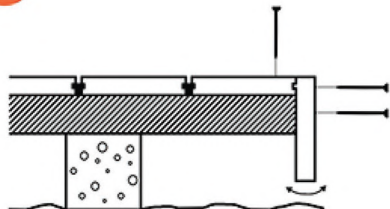

11

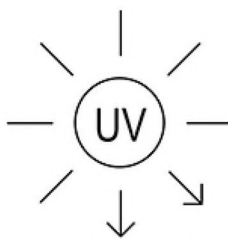

12

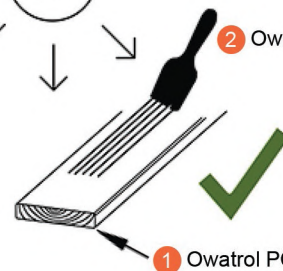
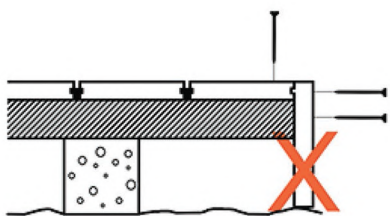
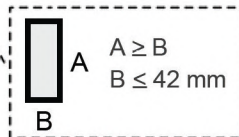
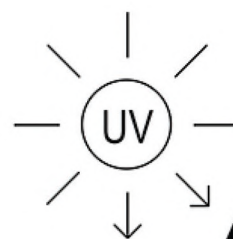

1 Owatron PCD 91

2 Owatron Aquatherm